

VF Series of LEDs Bargraph Meter Modules

vu140PC-11712S

40 Segments Fixed Color Audio Level Meter Module

VF

S

SUMMARIZE

VF series vu LED bargraph meter modules can accept and interpret audio signal and programme signal which is transmitted by lines and generate audio level for display. The module can achieve vu volume meter's bar display, bar display with peak-hold, dot display and dot display with peak-hold by keyboard. Sensitivity of transmission channel can be adjusted by the parts on module, so display's dynamic range can be adjusted easily.

Audio input can connect the signal to the preamplifier(circuit) or power amplifier output port by PH port connector or other two connectors. The signal is sent to the LED bar to display after mean detection, transfer amplification and processed by software. Because of wide impedance match range, the module can be widely used in the display of audio system's audio output, sound console output, programme signal transmitted by lines and volume output by power amplifier.

The module has wide range power supply, low power consumption. The bargraph can be a single color, such as red, green, yellow etc. or can be two or more colors to display separately, which represent different function region and improve the visual effect of programme.

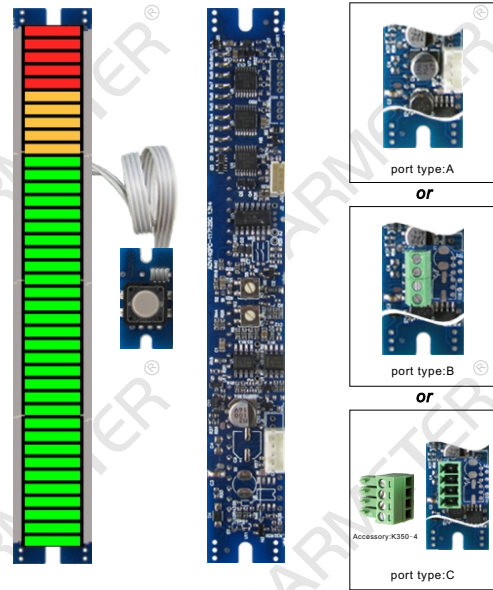

[Http://www.barmeter.com](http://www.barmeter.com)

DESCRIPTIONS

- **Input Impedance:** 200kohm,balanced
100kohm,unbalanced
- **Output Level For '0' Indication:** +4dBu(at default state)*
- **Input Range:** -20vu~+3vu(at default state)
- **Amplitude-Frequency Characteristic:** ±0.5vu[31.5Hz~16KHz]
- **Sensitivity Adjustment Range:** 3vu
- **Response Time:** 300ms ± 10%
- **Peak Hold Time:** 2 s
- **Peak Return Time:** 3 s
- **Effective Beam Number:** 40 segments
- **Bargraph Length:** 117 mm
- **Bargraph Width:** 12 mm
- **Active Area:** 12x118.8 mm
- **Segment Pitch:** 3.0 mm
- **Power Supply and Range :**
 - Non-isolated** Normal: DC5V±10%
Optional: DC12V (10~15V)
DC24V (20~28V)
 - Isolated** DC5V±5%, DC12V±5%, DC24V±5%
Insulating Intension: DC1000V 1min
- **Power Consumption:** 450mW(F.S.)
- **Environment:** -30~70°C & <85%RH

* default state: the 41th segment is the '0' reference indication, dBu is the decibel unit which take 0.775V as parameter value.

ORDER CODE

Bar Color	Red	Green	Yellow	30Green+5Yellow+5Red
Order Code	7011	7021	7031	7041

MODEL AND ORDERING CODE

vu140PC-11712S 05 C A 710411

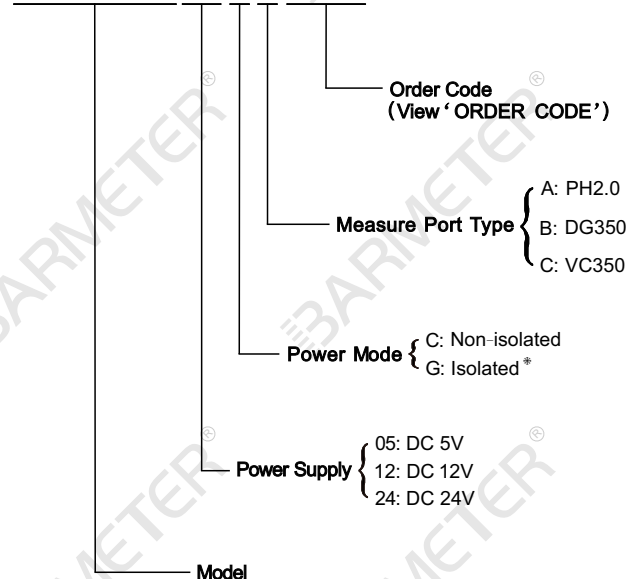

* When choose isolated power mode, signal's unbalanced input cannot be used.

VF Series of LEDs Bargraph Meter Modules

vu140PC-11712S

40 Segments Fixed Color Audio Level Meter Module

VF

S

DIMENSION AND LOCATION OF THE PORT

MODULE

Unit:mm

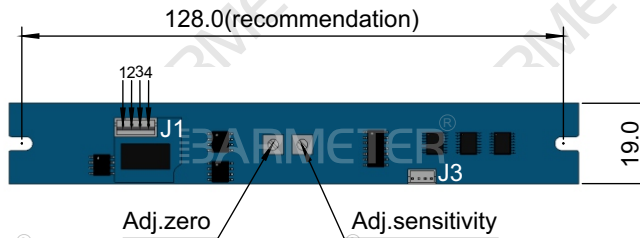
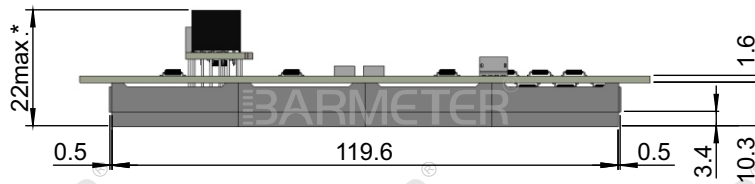
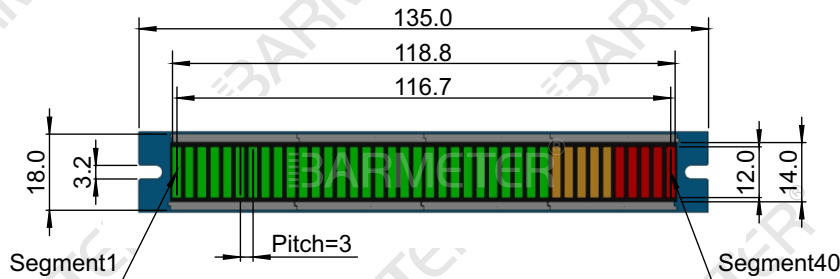

- * When choose measure port type A and isolated power supply.
- ※ When choose measure port type B (or C) and isolated power supply.

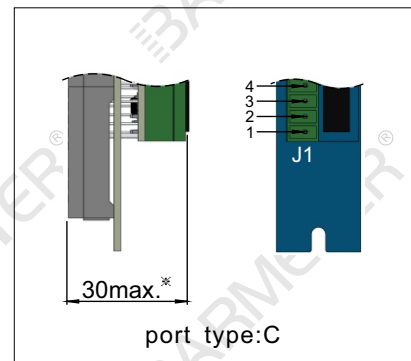
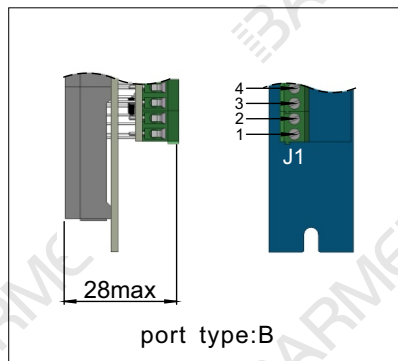
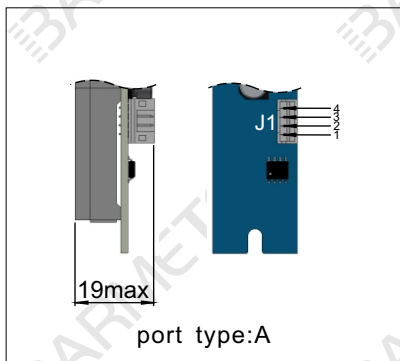

VF Series of LEDs Bargraph Meter Modules

vu140PC-11712S

40 Segments Fixed Color Audio Level Meter Module

VF

S

PORT(J1) DEFINITION AND OPTIONS

Pin No.	Symbol	Wire color	Definition
1	PS(-)	Black	Power Supply Negative
2	IN(C)	Blue	Audio Input Cold Side
3	IN(H)	Yellow	Audio Input Hot Side
4	PS(+)	Red	Power Supply Positive

CONNECTOR (Accessories for port type A)

WPH-204L25-1

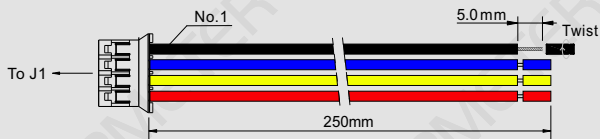

AMPHENOL CONNECTOR (Accessories for port type C)

K350-4

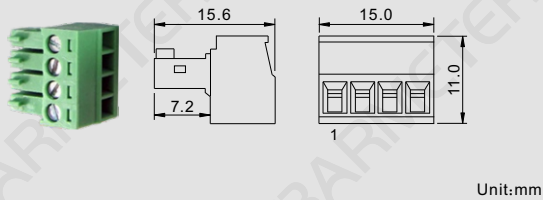

KEYBOARD

K1B12L20-1

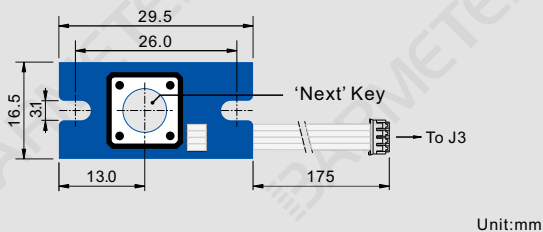

NOTES

Press the 'Next' key repeatedly, the module can switch with bar display with peak-hold, bar display, dot display with peak-hold and dot display.

The display mode has memory function. The mode will stay until the 'Next' key is pressed.

APPLICATION EXAMPLES

BALANCED INPUT CONNECTIONS

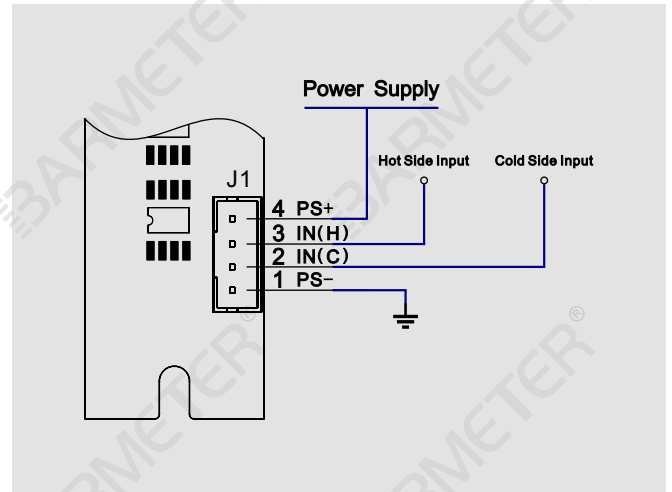

UNBALANCED INPUT CONNECTIONS

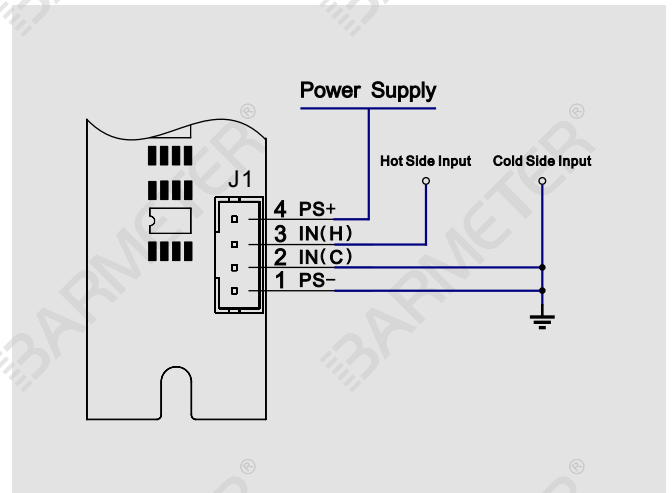

COPYRIGHT NOTICE

Barmeter Electronics possess industrial and intellectual property rights including product appearance, hardware circuit and software, which are protected by patents and copyright. Any organization or individual can not compile and issue this datasheet without our authorization. The function of our products is continuously improving and the version of datasheets will be updated in time. Hope customers will give attention to us.